

Light arrow Mobile warning board (FA2)

consisting of

- Control unit
- Input devices
- Lights
- Actuators

horizont

horizont group gmbh
Traffic Safety

Postfach 13 40
34483 Korbach

Homberger Weg 4-6
34497 Korbach
Germany

Telefon: +49 (0) 56 31 / 5 65 - 2 00
Telefax: +49 (0) 56 31 / 5 65 - 2 48

traffic@horizont.com
www.horizont.com



Original manual

Mobile warning board FA2

Safety instructions	2
Regular maintenance	7
Short product description	8
Technical data	8
Operation	9
Remote control	9
Features	11
Features of the upper board (FA2 trailer)	14
Light patterns FA2 (Standard)	15
Optional accessories (remote controls)	15
Wiring diagram	16
Spare part list	18
Optional accessories (remote controls)	20
Autodiagnosis of the main controller and the complete system	22
Status display	23
Troubleshooting	23
Operation without LED auxiliary lamps	24
Operation with rotating arrow	25
Connection diagrams	25
Electromotive lifting and lowering device	26
Adjusting the proximity switches	27
Operation of the trailer with three additional headlines	27
Connection sequence of the lamps	28
Wiring diagram housing FA2	29
Short Description „Cradle for the remote control-drilling plan and installation“	30

Safety instructions

Before carrying out any work on the device it has to be switched off!

General information on the user manual

This operating instruction provides important information on how to work with the device.

All technical information in this manual has been compiled with the utmost of care. We can, however, not exclude discrepancies or mistakes and do therefore neither assume warranty nor any legal liability nor liability for any consequential damages due to incorrect information.

We highly appreciate any information on possible mistakes or discrepancies!

The basic prerequisite for safe working is compliance with all safety and handling instructions stated in this manual.

Furthermore, the local accident prevention as well as safety regulations have to be observed.

The operating instructions must be read carefully before starting any work!

It is part of the product and must be kept in safe place in the immediate vicinity of the device, accessible at any time for the personnel.

If you sell or distribute this product, make sure to also hand out this manual.

For better visualization, the illustrations in this manual are not necessarily true to scale and may differ from the actual design.

General safety instructions

Meaning of pictograms

Safety notes are characterised by pictograms.

Additionally they are precluded by signal words, expressing the scale of the hazard.

- Safety Instructions must be duly observed under all circumstances!
- Always act cautiously in order to avoid accidents, personal injuries and damage to property!

Warning!



Indicates a potentially dangerous situation which can result in death or severe injuries if not being avoided.

Caution!



Indicates a potentially dangerous situation, which may lead to minor or light injuries if not being avoided.

Caution!



Indicates a potentially hazardous situation that may result in property damage if not being avoided

Hints and recommendations

NOTE!



Highlights useful hints and recommendations as well as information for an efficient and trouble-free operation.

Limitation of liability

All information and instructions in this manual were compiled under consideration of all valid and applicable standards and regulations, our state of the art technique as well as our long-term experience and knowledge.

The manufacturer assumes no liability for damage due to:

- Non-observance of the operation and maintenance instructions
- Improper / unintended use
- Deployment of non-trained personnel
- Unauthorized conversions
- Technical changes
- Use of non – approved / unauthorized spare and wear parts

In case of ordering customized versions, use of additional options or due to state of the art technical alterations the actual scope of supply may differ from the explanations and illustrations described in this manual.

Additionally the responsibilities agreed upon in the delivery contract, the general terms and conditions as well as the manufacturer's conditions of delivery and the statutory provisions valid at the time of contract conclusion shall apply.

Warranty

Wear parts are all components having direct contact with the material processed by the machine. These components are excluded from warranty and defect claims provided it is wear.

Warranty

The manufacturer guarantees the functional capability of the process technology used and the stated performance parameters. The warranty period begins at the time of acceptance without defects.

Warranty

The individual warranty conditions can be found in the sales contract.

In general rules:

In case of conversions or technical modifications which were not certified by horizont group gmbh, any warranty claims expire.

Repairs to the towing device of the vehicle may only be carried out by certified workshops or the manufacturer itself.

Spareparts

Warning!



Incorrect or faulty replacement parts may lead to damages, malfunctions or even total breakdown of the device, thus severely affecting the safety.

Always use original spare parts only!

Original spare parts can be obtained directly from the manufacturer.

Customer service

In case you need any technical information or advice, our customer service is at your disposal.

Furthermore our employees always appreciate receiving feedback from the user - such as experiences arising during the application - in order to constantly work on improving our products.

Copyright

This manual is intended exclusively for persons working with the unit. This manual may not be passed on to third parties without the written consent of the manufacturer.

In case you need any technical information or advice, our customer service is at your disposal.

Furthermore our employees always appreciate receiving feedback from the user - such as experiences arising during the application - in order to constantly work on improving our products.

NOTE!



Any content of this instruction like texts, drawings, pictures and other representations are protected by copyright law and subject to industrial property rights. Any improper use is punishable. Reproduction in any form - even in extracts - as well as the utilization and / or communication of the contents are not permitted without written consent of the manufacturer. Violations require compensation. Further claims remain reserved.

Safety

This section gives an overview of all important safety aspects for optimum protection of personnel and for a safe and trouble-free operation. Failure to comply with the safety instructions stated in this manual may lead to considerably hazardous situation.

Responsibility of the operator

The operator of the device is subject to the legal obligations for safety at work.

In addition to the safety instructions in this manual the safety standards, accident prevention as well as environment protection regulations on site have to be adhered to.

It is essential that the operator

- is informed about the applicable health and safety regulations on site.
- identifies additional hazards which might arise due to special working conditions at the operation site by means of a risk assessment.
- implements the necessary rules of conduct stated in the user manual at the operation site.
- check at regular intervals during the machine's entire period of use whether the user instructions correspond to the current state of rules.
- clearly regulates the responsibilities for installing, operating, maintaining and cleaning the device.
- ensures that all employees working on or with the machine have read and understood the operating instructions. In addition he must at regular intervals train the employees in how to deal with the machine and inform them about potential hazards.

In addition, it is the operator's responsibility to ensure that:

- the machine is always in a technically perfect condition.
- the machine is maintained in accordance with specified maintenance intervals.
- all safety equipment is regularly checked for completeness and correct functioning.
- the required inspections are carried out or arranged to be carried out at a self-defined or predefined time interval.

Staff requirements

Qualification

WARNING!



Inappropriate handling can lead to considerable personal injury and property damage. All activities should only be carried out by qualified personnel.

Hazards

The following section lists residual risks that were determined on the basis of a hazard analysis.

The hazard notes listed here and the safety instructions in the previous sections of this manual must strictly be observed to reduce possible health hazards and to avoid dangerous situations.

Electrical current

DANGER!



Touching live parts is an immediate risk of fatal injury. Damage to the insulation or individual components can be potentially life-threatening.

Repairs to the electrical system of the device may only be carried out by qualified electricians!

Before carrying out any work on the device, first disconnect the negative terminal and then the positive terminal on the rechargeable batteries.

Batteries & rechargeable batteries

WARNING!



Improper handling of batteries or rechargeable batteries may release toxic substances or even lead to their explosion.

During the charging process, explosive gas mixtures can originate. Therefore

- **you may not** smoke
- **you must avoid** sparking and ensure adequate ventilation
- **you may not** use any flammable cleaning agents in the immediate vicinity of the batteries !

Adhere to the instructions of your manufacturer for rechargeable batteries!

Environmental protection



CAUTION!

Rechargeable batteries contain toxic heavy metals. They are hazardous waste and must be collected and disposed of in accordance with the local applicable regulations. It is the owner's responsibility to inform about disposal regulations and disposal centres.

Intended use of the product

WARNING!



Any use of the device beyond its intended use or any other use not in accordance with the instructions may lead to dangerous situations for which **horizont group gmbh does not assume any responsibility.**

For this reason:

- you may only use the device for its intended purpose.
- you have to strictly follow all instructions in this manual. In particular, refrain from the following operations, which are deemed to be improper: modification, conversion or alteration of the construction or individual equipment parts with the aim of altering the usability of the device. Claims of any kind for damage resulting from improper use are excluded. The operator alone is liable for all damage resulting from improper use.

WARNING!



Installation and operation of the light arrow on public roads may only be carried out in compliance with the local applicable regulations (**in Germany RSA, TL warning lights, StVO!**)

WARNING!



During the process of lifting/ lowering of the light arrow no persons may be in the vicinity of the light arrow. Furthermore, no objects may be transported in the area of the light arrow which obstruct, block or endanger the operation of the light arrow (vertical sliding arrow).

WARNING!



When switching off the light arrow via the remote control, the position of the rotating arrow remains the same. It is **not** automatically turned to the centre (neutral) position

WARNING!



Driving into the flowing traffic with the light arrow

- when the light arrow is mounted fix to the rear of the vehicle, the maximum speed allowed is 150 km/h.
- when mounted on a lifting and lowering device, the maximum speed allowed is:
 - 30 km/h in upright position,
 - 150 km/h in lowered position (arrow on lifting/lowering frame)
- when properly mounted on a flatbed vehicle behind the driver's cab, the maximum speed allowed is 80 km/h (vertical sliding frame).

CAUTION!



When operating the device on the vehicle's electrical system, the electrical circuit must always be protected accordingly.

Regular maintenance



Recharge the batteries after each use and check the acid level at regular intervals. If necessary, re-fill with distilled water and pay particular attention to corrosion of the terminals.



Check the light arrow for visible damage.



We do not recommend cleaning the unit with high-pressure cleaners. Avoid chemical cleaning agents.



In case the light arrow is not used for a longer period of time, disconnect the rechargeable battery and check the charging level.



Store the unit in a dry place

Short product description

The light arrow is suitable for stationary and mobile use on motorways, expressways, federal and rural roads as well as in inner-city areas. The locally applicable regulations must be observed:

in Germany RSA, TL warning lights, StVO.

The light arrow is equipped with LED lamps. It is available in three versions depending on the construction: with electric lifting, manual lifting or fixed mounting.

Operation is done via an external remote control. The device can be used universally in 12Volt or 24V on-board networks. LED lamp monitoring, night reduction of the lamps and deep discharge protection are integrated. The lamp monitoring indicates a failure in the signal image, depending on the fault, by the yellow or red LED lighting up in the remote control.

The dimming reduces the luminosity of the LED lamps depending on the ambient luminosity (to protect motorists from dazzling).

The deep discharge protection switches the device off once the battery is discharged (battery protection).

The main control is located in the control box. All electrical connections are spring connected to the main control, with the exception of the lifting actuator and power supply.

The circuit board can be removed after loosening the fixing screws, removing the spring connectors, loosening the motor cables and supply cable.

Technical Data

Nominal operating voltage	12/24 V
Max. operating voltage	30 VDC
Min. operating voltage	10 VDC
Max. actuator current	10A
Light ducts	16
Outputs for additional lamps	2 (max. à 6 A)
Automatic switch – off light arrow (deep discharge protection)	at 10 V (temporarily at lifting / lowering actuator)
Provide fuses on the vehicle.....	min. 25 A

Radio remote control

Transmitting frequency	2,4 - 2,48 GHz
Transmission performance.....	10 mW
Operating hours of the system with 1 x 180 Ah / 12 V battery (approx. with completely charged battery)	

Signals	LEFT showing	/ RIGHT showing / CROSS	Day	Night
		with mit LED – lamps	100 h	250 h

Operation

The entire operation is carried out by means of the remote control.

- Switch on the remote control
- If existing, release the locking lever of the board's lifting mechanism.
(This is only necessary in case of manual locking and electromotive uprighting)
- Select the desired function on the remote control.
- **Green flashing**, respectively **green static light** of the control LEDs indicates correct functioning of the chosen feature on the remote control.

The **LEFT ARROW**, **RIGHT ARROW** and **CROSS** functions can only be activated when the board is fully upright. On the remote control, the **PANEL UP** indicator must light up (except for fixed installation).

When the panel is only partially upright, only the auxiliary lamps, if fitted, are active.

Alternatively, the panel can be raised using the LEFT ARROW, RIGHT ARROW and CROSS keys. When the position is reached, the selected light pattern is activated.

Remote control

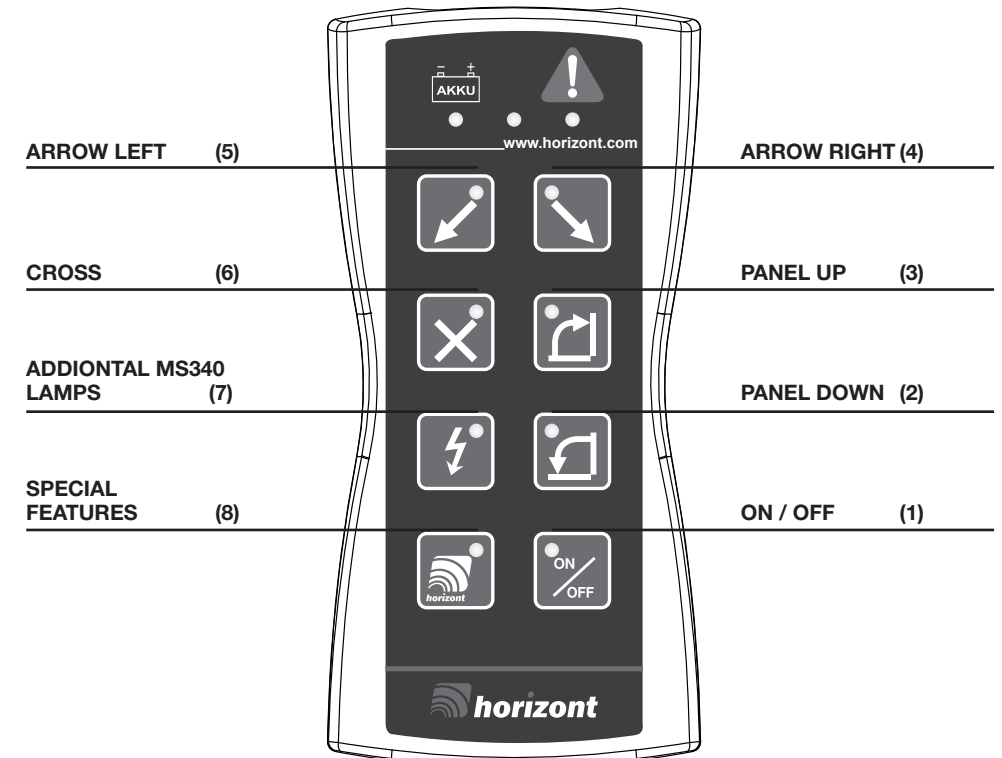

The LEDs on the remote control are dimmed depending on the ambient light conditions. At a certain ambient brightness the buttons (outline and symbols) are additionally illuminated.

BATTERY CONDITION INDICATION

green →	> 12,1 V	(> 45%)
yellow →	12,1 V > Ubatt < 11,8V	(20% - 45%)
red →	< 11,8 V	(20%)

ERROR DISPLAY

red → error indication

ACOUSTIC ERROR INDICATION

At mobile warning trailers, malfunctions will also be indicated by an acoustic signal.

WIRELESS (RADIO) REMOTE CONTROL

The radio remote control contains a high quality Ni-Mh battery. As soon as the cable is connected, it is automatically charged via the internal charge controller.

The charging time of the empty battery is about two hours. During operation, the status of the internal battery is displayed in intervals of approx. 10 seconds in the battery condition display. This is indicated by flashing of the LED.

Flashing green:	Remaining capacity	<40 %
Flashing yellow:		<20 %
Flashing red:		<10 %

In addition, an acoustic warning signal is emitted by the remote control when reaching its low battery capacity. Operating time with fully charged battery approx. 10 hours (continuous operation).

 In radio mode, the remote control switches off after approx. 5 minutes.

 In cable mode the remote control does not switch off.

When the cable is plugged in, there is no radio communication with the control unit !

CHARGING INDICATOR (RADIO) / OPERATING STATUS INDICATOR (CABLE)

When the charging cable or data cable is plugged into the remote control during radio operation (with the remote control and main control switched off!), the LED at the ON/OFF button lights up yellow for approx. 30 minutes. This indicates that the remote control is supplied with power and the charging device is working.

 Charging continues automatically even if the yellow LED turns off. The charging indicator can be reactivated by pressing the ON/OFF button very briefly. This is for information purposes only!

To switch on the control unit or the remote control in this state, press and hold the ON/OFF key pressed (see description below).

If no connection can be established, the remote control switches off automatically after a few seconds in radio operation and after approx. 5 minutes in cable operation.



The internal charging device allows charging between a temperature of +5 C° and +60 C.

This is a technical necessity in order to ensure the long service life and operational safety of the internal battery. However, the yellow charging indicator continues to light up yellow beyond the temperature range as described.

CAUTION!









The socket on the remote control must be closed with the supplied protective cap when the cable is not plugged in.

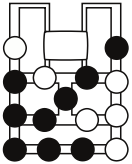

Otherwise there is a risk of water penetrating the housing and damaging the electronics.

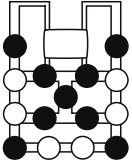

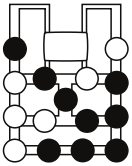
The bayonet lock must always be closed, even when the plug with cable is plugged in.

Features

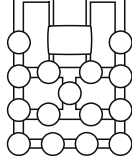
	<p>SWITCH ON Press key for approx. 1 seconds .</p> <p>LED indication (1):</p> <p>green → connection with main control was established successfully</p> <p>red → connection with the main control could not be established - no communication or control system has switched off due to under voltage</p> <p>SWITCH OFF → press key for approx. 4 seconds until the LEDs of key 4 (arrow right) and key 5 (arrow left) light up in red colour. Release key</p> <p>Working with the radio version, the arrow itself is also switched off provided a radio connection is established. A working radio connection is indicated by the red LEDs (4) and (5). If there is no radio connection, the LEDs light up yellow.</p>
	<p>SWITCH OFF Press and hold the button for approx. 4 seconds until the LED indicators on the button (4) and (5) lights up. Release the button.</p> <p>LED shows yellow → main control unit has been successfully switched off, remote control will switch off automatically after a few seconds</p> <p>LED shows flashing red → status of the control unit unknown or no feedback received from the control unit. Occasionally this can occur with radio remote controls with weak reception.</p> <p>If there is no response from the control unit, the software of the remote control attempts to establish a connection for approx. 1 to 2 seconds, which is indicated by the battery LED flashing rapidly in yellow.</p> <p>The LEDs mentioned previously will then flash.</p> <p>CAUTION!</p> <p>If the LEDs at buttons (4) and (5) flash red please visually check the position of the rotating arrow and the operating status of the system.</p> <p>Alternatively, you can try to re-establish the connection to the control unit by switching it on and off again.</p> <p>Further information is provided under the heading „FA2 boards“.</p>

	 Arrow left	<p>Press key, the LED (5) flashes in the same frequency as the light arrow does:</p> <ul style="list-style-type: none"> green → all lamps work properly yellow → one lamp is defective or cable break or cable interruption or short circuit red → two or more lamps are defective or cable break or interruption red flashing → Interruption or fault of the proximity switches of the rotating arrow (rotating arrow is no longer in its final position) <p>When using the light cross (HLK 9), the device will show „Cross“ automatically in this case.</p>
	 CROSS	<p>Press key , the LED (6) flashes in the same frequency as the light arrow does:</p> <ul style="list-style-type: none"> green → all lamps work properly yellow → one lamp is defective or cable break or cable interruption or short circuit red → two or more lamps are defective or cable break or interruption red flashing → Interruption or fault of the proximity switches of the rotating arrow (rotating arrow is no longer in its final position)
	 Arrow right	<p>Press key, the LED (4) flashes in the same frequency as the light arrow does:</p> <ul style="list-style-type: none"> green → all lamps work properly yellow → one lamp is defective or cable break or cable interruption or short circuit red → two or more lamps are defective or cable break or interruption red flashing → Interruption or fault of the proximity switches of the rotating arrow (rotating arrow is no longer in its final position) <p>When using the light cross (HLK 9), the device will show „Cross“ automatically in this case.</p>

	 Additional lamps	<p>Press key, The currently shown signal is switched off, only the additional lamps keep flashing, The LED (7) flashes in the same frequency as the light arrow does:</p> <ul style="list-style-type: none"> green → all lamps work properly red → two or more lamps are defective or cable break or interruption LED off → additional lamps are de-activated <p>When using additional lamps, you may only use horizont LED MS 340 lamps, which can work as halogen- imitating or flash- imitating lamps.</p>
---	--	---

 Lower board	<p>Press key and keep pushed until the board has reached its final position (dead man's switch), board is lowered Signal image of the spot illumination (2): Flashing green → the lifting/lowering actuator is active, end position not yet reached Lit up green → final position is reached Red flashing → Error: Time exceeded or cable interruption of sensor</p>
 Lift board	<p>Press key and keep pushed until the board has reached its final position (dead man's switch), Pun Signal image of the spot illumination (3): Flashing green → the lifting/lowering actuator is active, end position not yet reached Lit up green → final position is reached Red flashing → Error: Time exceeded or cable interruption of sensor</p>
	<p>Press key: special features (such as work lamp, etc) are activated (z.B. work light) Signal image of the spot illumination (8): green → additional outputs activated off → additional outputs de-activated</p>

Features of the upper board (FA2 trailer)

FA2 trailer with manual raising of the board

- unlock the upper board by releasing the safety catch on the clamping lever
- unlock the levelling rod and lift the upper board with the levelling rod to a vertical position
- lock the levelling rod at the framework

FA2 trailer with electro-mechanical raising of the upper board

- press the „PANEL UP“ button until the upper board is vertical and the motor has switched off
- to lower the board, press the „DOWN BOARD“ button until the board rests firmly on the rubber supports
- The cargo bed of the FA L trailer may only be loaded with the rear supports lowered and locked when the towing vehicle is uncoupled

This also applies to opening of the loading ramp.

CAUTION!



Before each operation of the upper board, make sure that the supports are extended, engaged and locked.

When working with trailers equipped with manual lifting / lowering of the upper board, you have to make sure that the upper board is fully raised in order to be able to activate the functions of remote control.



All movements of the board are automatically stopped when the respective end position is reached (proximity switch) or the corresponding button on the remote control is released (dead man's switch).

Light patterns FA2 (standard)

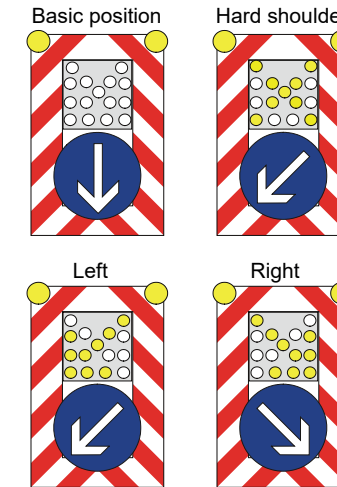

CAUTION!



When the light arrow board is switched on and/or off via the remote control as well as when it is lowered (manually or electrically), the rotating arrow is always positioned „to the centre“ or „arrow down“, regardless of the position of the board.

When switching the system on again, the user has to select the desired light pattern and thus the position of the rotating arrow by means of the remote control.

If the system is switched off using the main switch, the light pattern previously selected is activated again when the system is switched on again. For this reason, you should always switch off the system first using the remote control and then, if desired, using the main switch!



The main control unit of FA2 trailer provides the „Follow arrow“ feature, i.e. if the rotating arrow is defective, it can be manually moved to the desired position (depending on the actuator installed). An acoustic error signal is then briefly emitted by the control unit. After this, the light arrow image will automatically „follow“ the rotary arrow and the corresponding light arrow image will be activated:

Accessory available on request (Radio remote control)

LED Remote control

The light arrow can also be operated with other remote controls from the FA1 programme.

These are available in different versions:

LED remote control with cable:

Artikel 21153-0003

LED remote control cable /radio:

Artikel 21154-0003

Light arrow

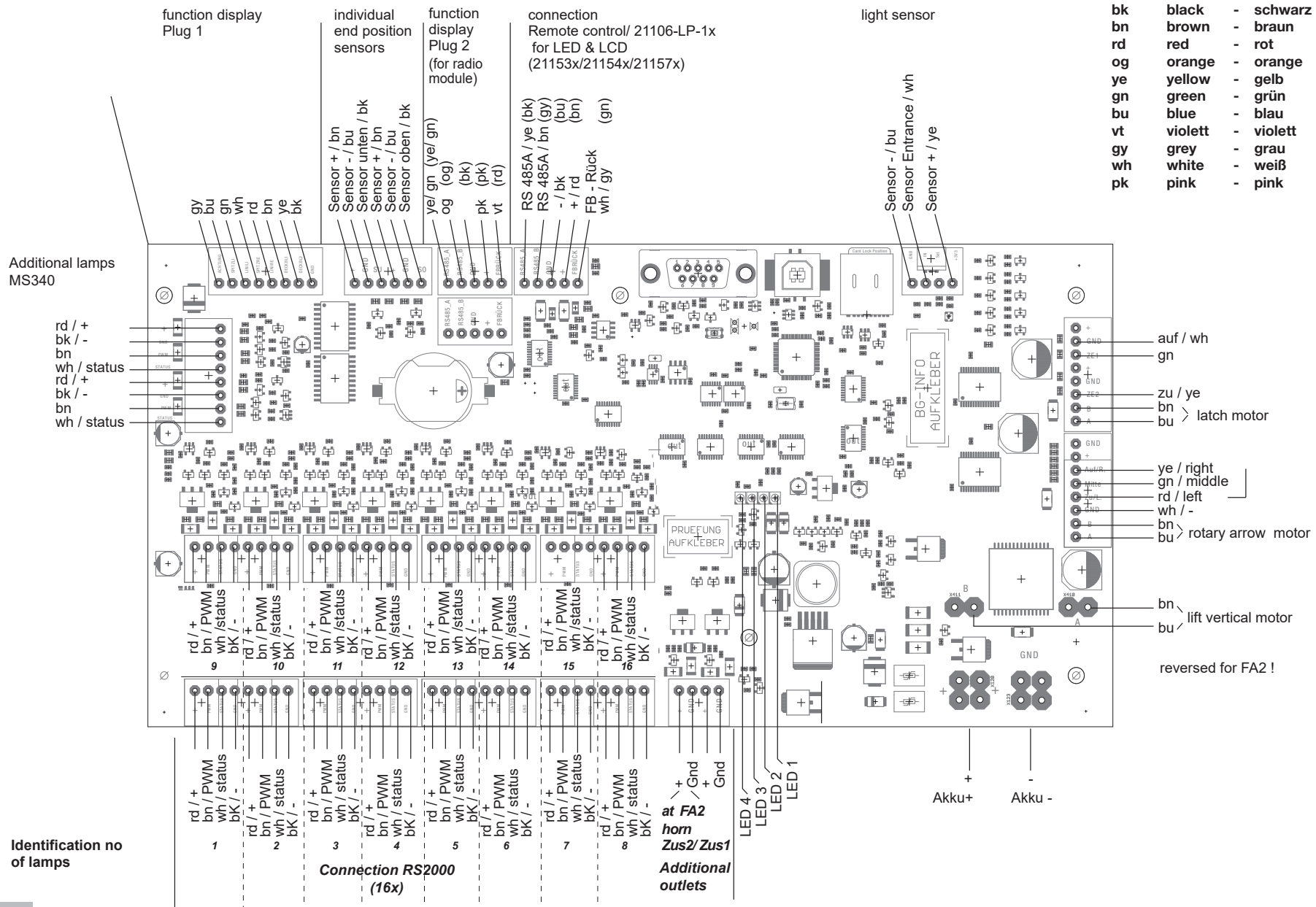

Overview spare parts

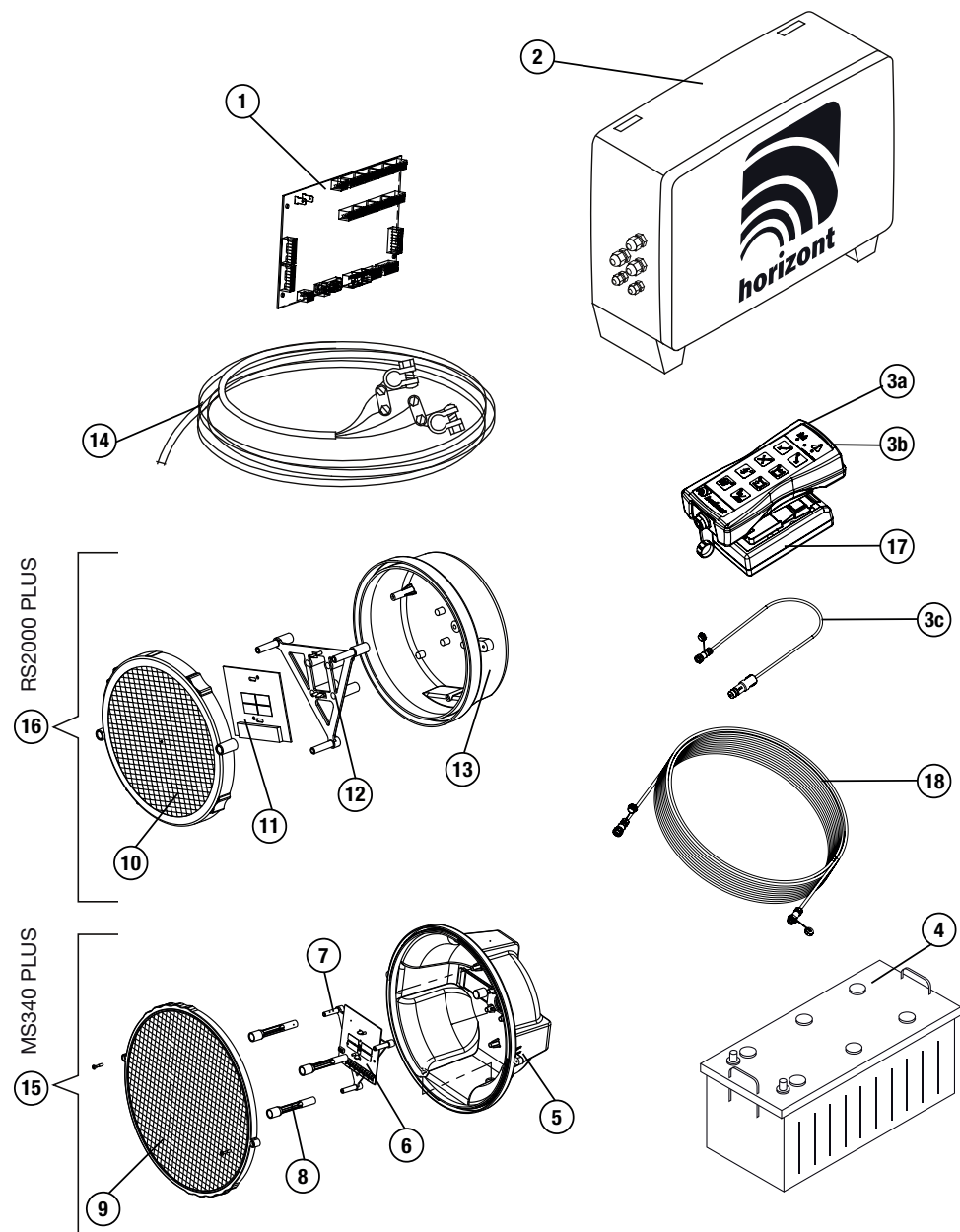

Pos.	Part. no.	Denomination
01	82219VP	Main control unit FA2
02	21021STGOE-1	Housing without electronics
03a	21106LP-1HVP	Cable remote control, 10m
03b	21106LP-1FVP	Radio remote control
03c	82366	Charging cable with vehicle plug
03d	82367-20M	20 metre cable with plug
04	25014	Rechargeable battery 12V/180Ah
05	925362	Housing MS340PLUS
06	82349	Circuitry MS340PLUS
07	84918	Holder circuitry MS340PLUS
08	87884	Adapter for holder circuitry MS340PLUS
09	87883	Lense MS340PLUS
10	84911	Lense RS2000PLUS
11	82343	Circuitry RS2000PLUS
12	84890	Holder circuitry RS2000PLUS
13	211940TG	Housing RS2000PLUS
13a	21194PGOT	Housing with double membrane feed-through at the rear with PG7 screw connection at the bottom
14	82360	Cable for battery 6 m with clamps
14a	82360-15M	Cable for battery 15 m with clamps
15	20828PLUS	Complete lamp MS340PLUS
16	211940T-1 21194PG-2	RS2000PLUS with double membrane feed RS2000PLUS with PG feed through
17	88815VP	Holder for remote control for the clip attached to the remote control
18	82373	Extension cable for remote control 10 metres

Accessory available on request (Radio remote control)

LED Remote control

The light arrow can also be operated with other remote controls from the FA1 programme. These are available in different versions:

LED remote control with cable: Artikel 21153-0003
 LED remote control cable /radio: Artikel 21154-0003

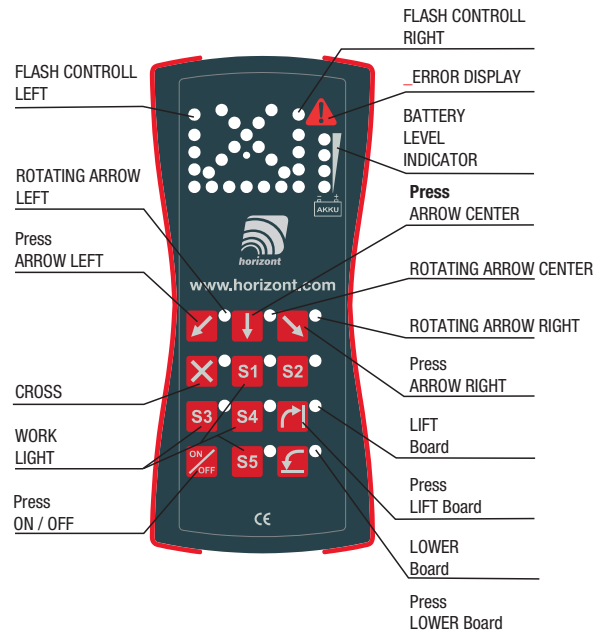

Defective lights are displayed on the remote control 1:1. The working lamp is switched on by key S3 (optionally the working lamp can also be switched on by key S1).

 A cable set with part number 820472-1 is required for the remote control!

For the feed-through in the control housing, the hole must be drilled to the size of a PG11 cable gland and fitted with a PG11 cable gland

LCD remote control

With cable / radio connection:



Observe acoustic and optical error signals when switching on.

Defective lights are displayed on the remote control 1:1. The working lamp is switched on by key S3 (optionally the working lamp can also be switched on by key S1).

 A cable set with the part number 820472-1 is required for the remote control !

For the feed-through in the control housing, the hole must be drilled to the size of a PG11 cable gland and fitted with a PG11 cable gland.

Self-diagnosis of the main controller and the system

The controller has extensive diagnostic features. Directly after switching on and during operation, the diagnosis is carried out continuously.



Shortly after switching on, the built-in horn emits a short sound. This is due to the self-test and is not a malfunction.

Cable interruptions, short circuits and undefined states

Cable interruptions of the inductive end position sensors, the proximity switches of the actuators (upright, rotary arrow or bolt motor) as well as of the lights (directional emitter and long range warning) are detected.

In addition, undefined states (e.g. both end position sensors active) are also detected and displayed accordingly. In certain cases, the light arrow is switched off.

Further error indications

After switching on, in addition to the previously described defects, further malfunctions are displayed via the LED of the remote control:

Lamps faults:

the keys „Arrow Right“, „Arrow Left“ and „Cross“ flash yellow or red if there is a cable interruption, a short circuit or defects of the LEDs in these lamp.

Proximity switches

of the lifting / lowering actuator: LEDs of both buttons (UP/DOWN) flash red, cable interruption or undefined state

Proximity switches

of the rotary arrow: LED on key "ON" flashes yellow: cable interruption or undefined status

Overvoltage / Undervoltage

The on-board voltage (12V or 24V) is automatically recognized by the controller after switching on.

Undervoltage control reaction (12V on-board power supply):

- under 11,6 V Warning
- under 11,2 V Arrow board is switched off, only MS 340 lamps keep flashing
- under 10 V Complete system is shut down

Overvoltage control reaction:

- higher than 16 V Complete system is shut down

Undervoltage control reaction (24V on-board power supply):

- under 23,2 V Warning
- under 22,4 V Arrow board is switched off, only MS 340 lamps keep flashing
- under 20 V Complete system is shut down

Overvoltage control reaction:

- higher than 32 V Complete system is shut down

CAUTION!



The self-monitoring of the security system does however not release you from the duty to constantly ensure that it is functioning properly. This is done by observing the remote control and the indicators fitted on the housing of the main control unit.

Especially in case of a defect of the microprocessor, error states are likely to occur which do not cause any warning by the signal horn or the remote control. If the continuous observation is not carried out, accidents with possibly fatal results may result.

Status display



The LEDs on the lid of the main control unit symbolize the light arrow and will light up synchronously with the signal image indicated by the light arrow. If one or more lamps are defective, this is indicated by the corresponding LED symbol on the lid flashing rapidly. If one of the advanced warning lamps (MS340) is defective, the corresponding LED on the lid automatically extinguishes. In addition, a red exclamation mark is displayed and the horn is activated in the event of a fault.

All faults are also displayed on the remote control.

Repairs and maintenance

CAUTION!



Repair and maintenance works should generally only be carried out by qualified personnel or if possible by the manufacturers on site

„Information for the expert /technical engineer“.

Complete breakdown

Please check:

- the battery terminals
- fuses (on-board)
- the supply voltage at the plug contacts of the main circuit board
- LED indicator lights on the control board (from right to left):
 - LED 1 lights up: power supply is provided
 - LED 1 and 2 light up together: power supply provided, CPU is switched on or active
- If no error has been detected up to this point, please contact our customer service

Softwareupdate

The software of the main control unit can be installed via the USB socket.

The control unit must be disconnected from the on-board power supply beforehand.

Now connect the control unit to the computer using a standard USB-B connection.

During the update, only LED 2 lights up if no power supply is connected.

Replacing the main circuit board

- disconnect the current supply at the rechargeable battery (first the negative and then the positive pole),
- open the enclosure of the maincontrol - disconnect the power supply cable by removing the flat plugs
- disconnect the multipoint connectors on the circuit board as well as all actuators, making sure that the main circuit board is not subject to any mechanical stress during this process! If necessary, create counter pressure at the position by holding the board firmly
- loosen the fixing screws of the circuit board and remove it
- The installation of the main circuit board is carried out in reverse order.

Defective circuit boards, remote controls etc. please send to the following address with a short error description:

horizont group gmbh

**Division gerätewerk
Reparaturabteilung
Homerger Weg 4-6
34497 Korbach, GERMANY**

Activation and de-activation of features

By means of adding or removing cable bridges, features can be activated, respectively de-activated.

Operation without additional MS 340 advanced warning lights

When operating without additional MS340 advanced warning lamps, the input „status right“ and „PWM“ must be connected with each other (wire bridge).

In this way the control unit recognizes, after switching on, whether additional headlights are connected and should be controlled. In this case the third LED on the main control unit lights up permanently.

Possibly existing cable feed-through for additional MS 340 LED advanced warning lamps must be sealed against water penetration.

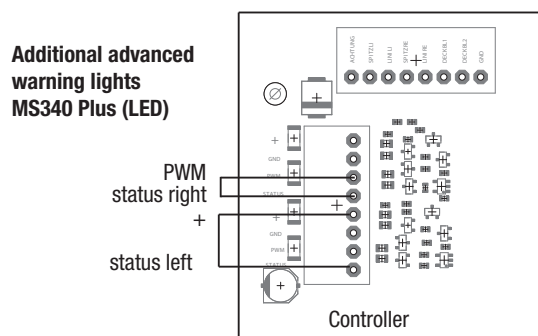

Operation with rotating arrow

In case the HLPK 15 is mounted on a warning trailer with rotating arrow device Wiring of the rotating arrow actuator

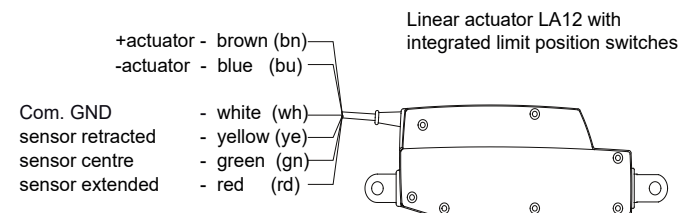

Connection diagrams

RS2000 PLUS 4D T0

MS340 PLUS 4D T0

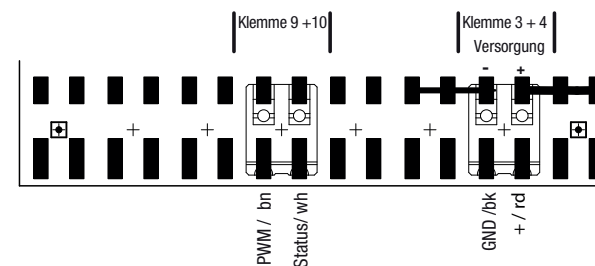

use small screwdriver to press down carefully

0,5 - 0,75mm²

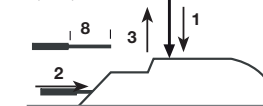

Connection clamp

The stripped, twisted cable is inserted into the connector so far that the insulation reaches the clamp housing!

Electronic lifting / lowering device

only for arrows in combination with electronic lifting lowering device or rotating arrow

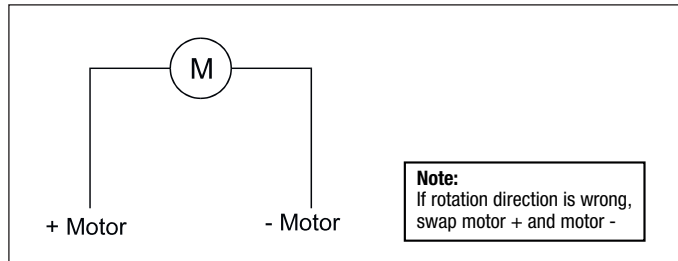

only for arrows with electronic lifting / lowering device

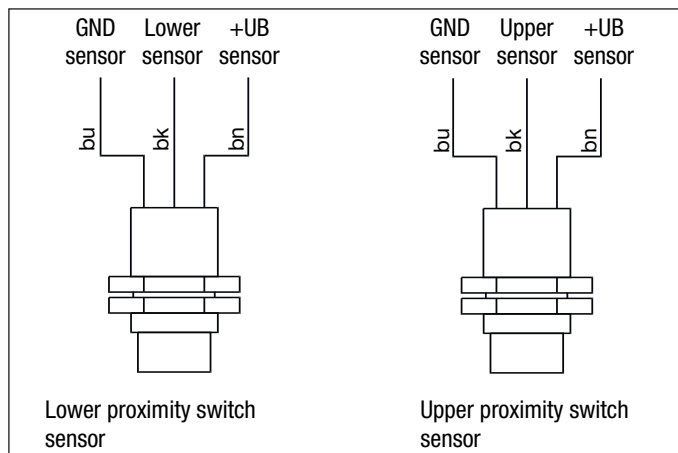

Adjusting of the proximity switches (collapsible arrow)

The proximity switches are pre-mounted, but should be checked for tight fit and correct limit switching points.

The proximity switch for the position „Light arrow folded down“ is located at the fixed part of the lifting device at the height of the mounting plate for the light arrow. It should be adjusted in such a way that it detects (LED lights up) as soon as the hinged frame touches the rubber stops.

The proximity switch for the position „Light arrow lifted“ is positioned on the hinged frame at the height of the pivot point. To adjust it, loosen the stop screws below the pivot point and then lift the light arrow until it is at a right angle to the roadway in 90° position. The angle is determined by the limit switch. The stop screws are then screwed back in again.

Please note: the limit switches must be fitted in such way that they do not touch the switch-off points on the frame under any circumstances.

Otherwise the limit switches will be destroyed.

CAUTION!



Please note that the motor has a short delay time for all settings - the lighting up of the LED in the proximity switch does not necessarily indicate an immediate stop and der Aufrichtung.

Operation of the trailer with three additional headlights

When operating the trailer with three additional headlights, the 15 lights of the light arrow are not required.

The three supplementary lamps are connected to channels RS2000PLUS 1 to 3. Channel 1 flashes in alternation with channels 2 and 3.

All functions, such as automatic dimming and monitoring of the spotlights, are maintained. The corresponding LED in the remote control lights up green when the rotary arrow is functioning correctly.

If the rotary arrow is in the centre position, the LED for the „Cross“ button lights up. However, the „Cross“ button itself has no functionality.

CAUTION!



Pressing the „Flash“ button causes the rotary arrow to turn to the centre position (arrow points downwards)

Wiring sequence of lamps

FA2 - 15 Lamps wiring sequence of lamps hardware

(Lights > Main control)

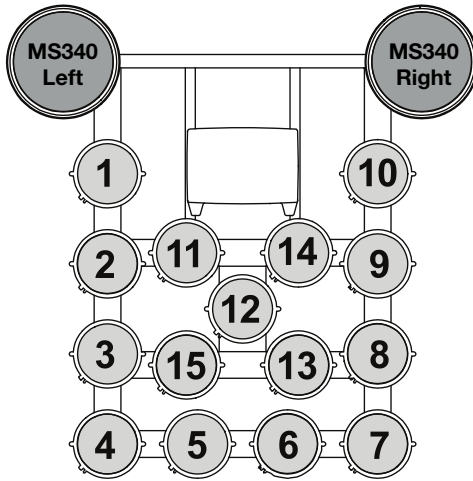
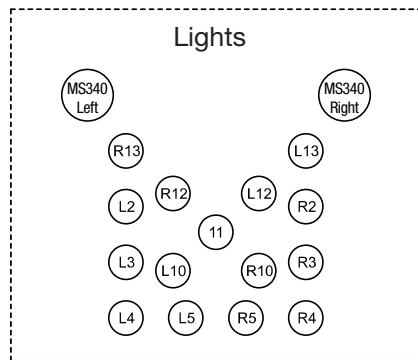

Illustration of the connection plan of the lights for remote control 21157 (LCD)

On the LCD remote control, the lights are displayed with different codes.

For example, the R13 on the remote control shows light no. 1, the L2 shows light no. 2, etc.



Connection plan enclosure main control FA2

(Bottom view)

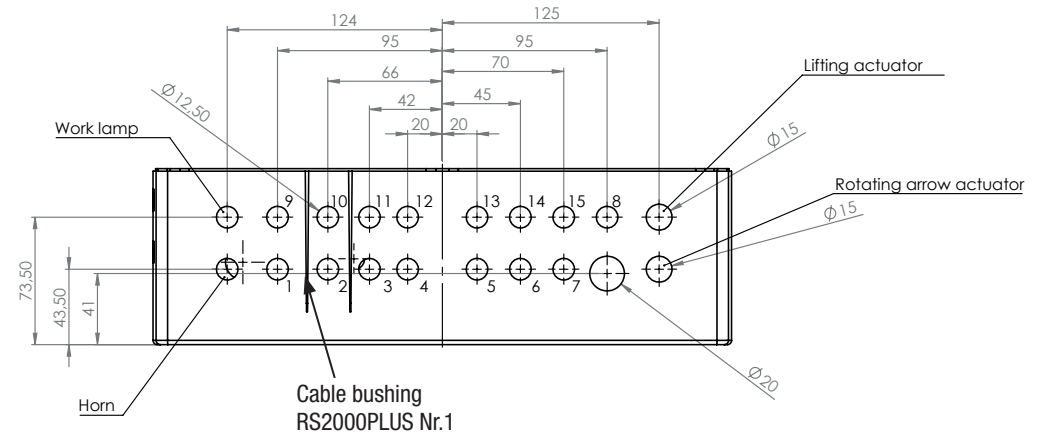

(Side view)

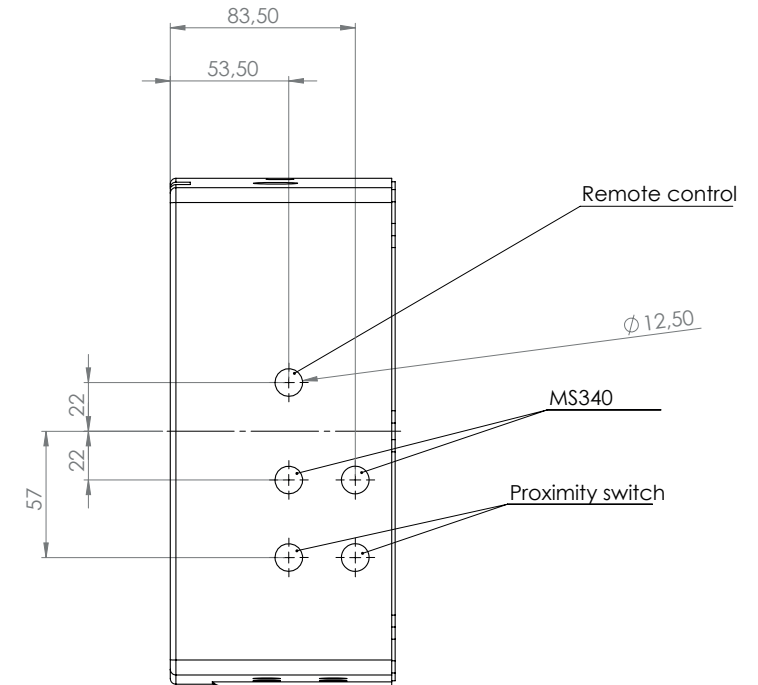

Quick guide: Cradle for the remote control (accessory item 88815VP)

Drilling plan and installation instructions

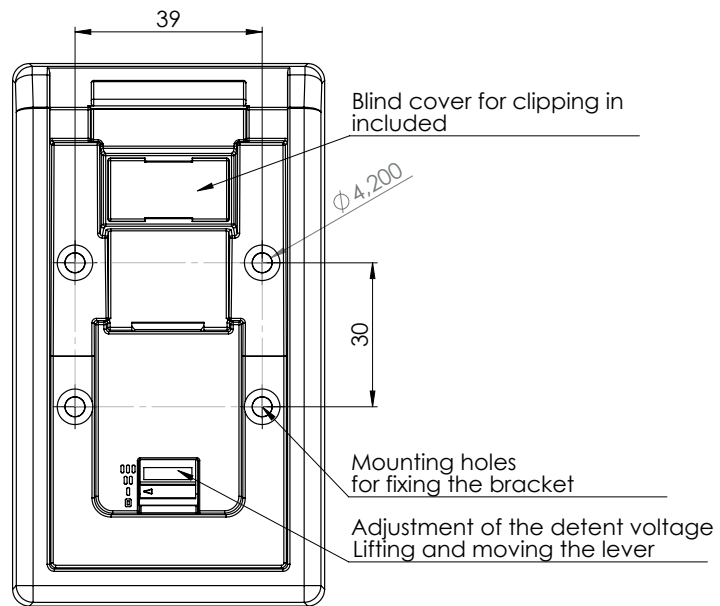

Schritt 1:

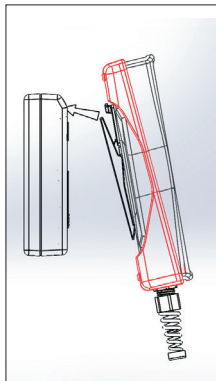

Schritt 2:

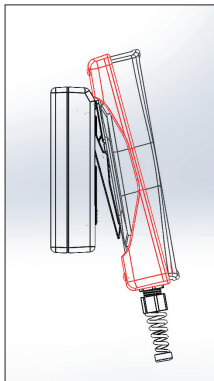

Schritt 3:

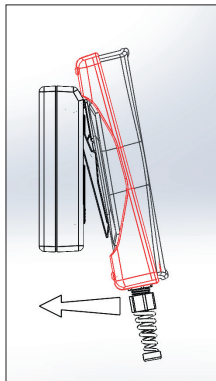

Schritt 4:

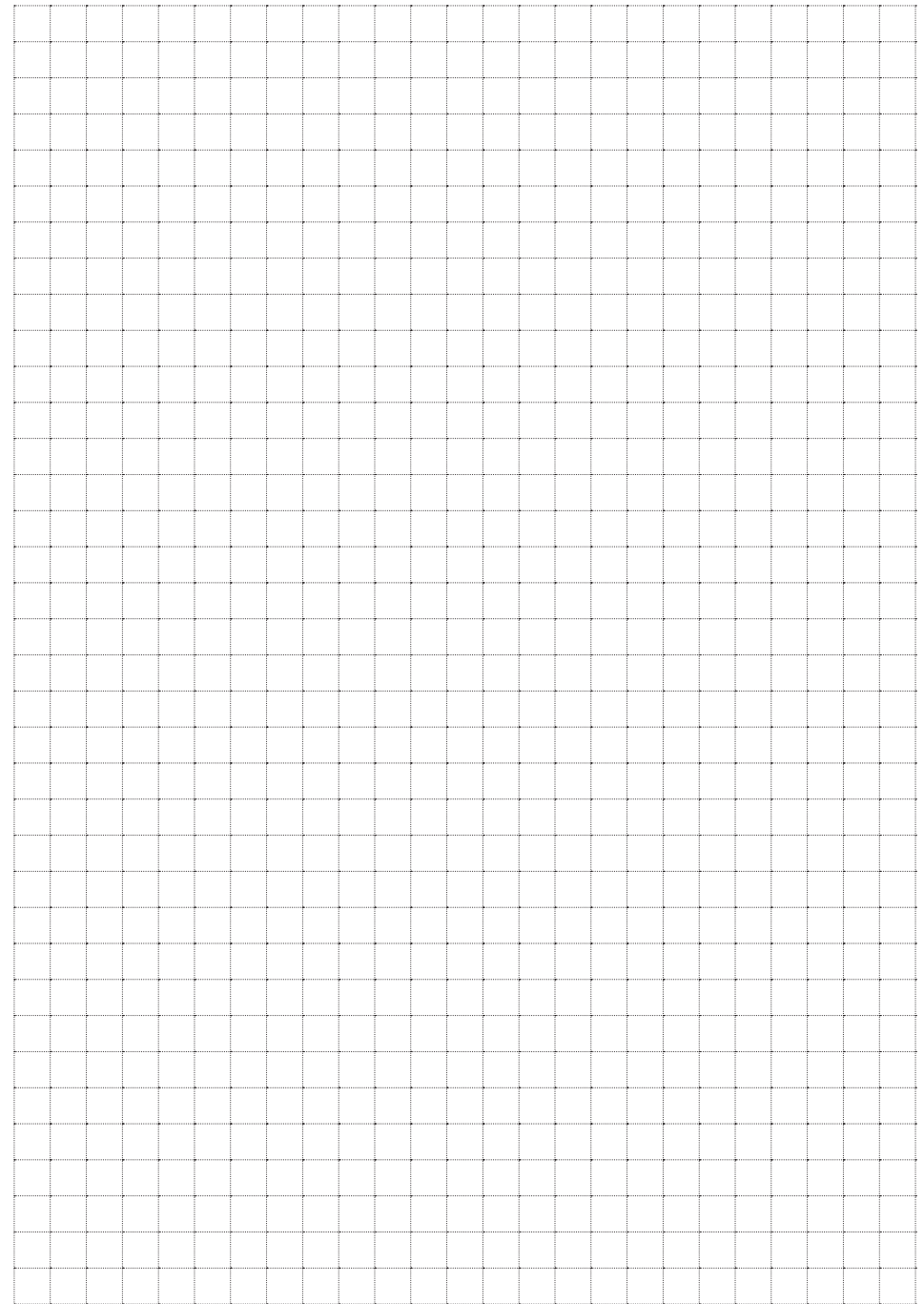
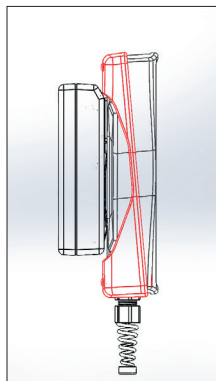



Konformitätserklärung Declaration of conformity Déclaration de conformité

Seite: 1

von: 1

Wir **horizont group gmbh**
Homerberger Weg 4-6, D-34497 Korbach

erklären in alleiniger Verantwortung, dass das Produkt

STG f. LP15 FA2 ohne FB&Softw	210211STGDR	Fernbedienung HLPK15	21106LP-1H
STG f. LP15 FA2	210211STGDR-15x	Fernbedienung HLPK15 Funk	21106LP-1F
STG f. LP15 FA2 ohne FB el. AA	210211STGDR-1502	Fernbedienung HLPK15 20m	21106LP-1H-20M
STG f. LP15 FA2 ohne FB man.AA	210211STGDR-1508		

(Bezeichnung, Typ oder Modell, Seriennummer)

auf das sich diese Erklärung bezieht, mit den EG-Richtlinien **2011/65/EU** (RoHS), **2012/19/EU** (WEEE), **2014/30/EU** (EMV), **2014/53/EU** (RED) und **2006/42/EG** (Maschinenrichtlinie) übereinstimmt und den Anforderungen folgender harmonisierter Normen entspricht:

DIN EN 50581 :2013, DIN EN 61000-6-2 : 2005 , DIN EN 61000-6-3 :2007 + A1:2011 und DIN EN 12100:2011, DIN EN 13850:2016, DIN EN 13857:2008, DIN EN 349: 1993+A1:2008, DIN EN 4413:2011, DIN EN 60204-1:2014, EN 62479:2010, EN 301 489-17 V2.1.1, EN 300 328 V2.1.1, EN 301 489-1 V2.1.1

We **horizont group gmbh**
Homerberger Weg 4-6, D-34497 Korbach

declare under our sole responsibility that the product

STG f. LP15 FA2 ohne FB&Softw	210211STGDR	Fernbedienung HLPK15	21106LP-1H
STG f. LP15 FA2	210211STGDR-15x	Fernbedienung HLPK15 Funk	21106LP-1F
STG f. LP15 FA2 ohne FB el. AA	210211STGDR-1502	Fernbedienung HLPK15 20m	21106LP-1H-20M
STG f. LP15 FA2 ohne FB man.AA	210211STGDR-1508		

(name, type or model, lot, serial number)

to which this declaration relates is in conformity with the European Directives **2011/65/EU** (RoHS), **2012/19/EU** (WEEE) **2014/30/EU** (EMC), **2014/53/EU** (RED) and **2006/42/EG** (machinery directive) and complies with the following harmonised standards

DIN EN 50581 :2013, DIN EN 61000-6-2 : 2005 , DIN EN 61000-6-3 :2007 + A1:2011 und DIN EN 12100:2011, DIN EN 13850:2016, DIN EN 13857:2008, DIN EN 349: 1993+A1:2008, DIN EN 4413:2011, DIN EN 60204-1:2014, EN 62479:2010, EN 301 489-17 V2.1.1, EN 300 328 V2.1.1, EN 301 489-1 V2.1.1

Nous **horizont group gmbh**
Homerberger Weg 4-6, D-34497 Korbach

déclarons sous notre seule responsabilité que le produit

STG f. LP15 FA2 ohne FB&Softw	210211STGDR	Fernbedienung HLPK15	21106LP-1H
STG f. LP15 FA2	210211STGDR-15x	Fernbedienung HLPK15 Funk	21106LP-1F
STG f. LP15 FA2 ohne FB el. AA	210211STGDR-1502	Fernbedienung HLPK15 20m	21106LP-1H-20M
STG f. LP15 FA2 ohne FB man.AA	210211STGDR-1508		

(nom, type ou modèle, numéro d'échantillon ou de série)

auquel se réfère cette déclaration est conforme aux Directives Européen **2011/65/EU** (RoHS), **2012/19/EU** (WEEE), **2014/30/EU** (CEM), **2014/53/EU** (RED) et **2006/42/EG** (directive <<machines>>) et répond aux respect des normes harmonisées

DIN EN 50581 :2013, DIN EN 61000-6-2 : 2005 , DIN EN 61000-6-3 :2007 + A1:2011 und DIN EN 12100:2011, DIN EN 13850:2016, DIN EN 13857:2008, DIN EN 349: 1993+A1:2008, DIN EN 4413:2011, DIN EN 60204-1:2014, EN 62479:2010, EN 301 489-17 V2.1.1, EN 300 328 V2.1.1, EN 301 489-1 V2.1.1

Datum: 30.09.2019

horizont group gmbh

Geschäftsführer: Rechtsverbindliche Unterschrift
Managing Director: Legally binding signature
Gérant: Signature obligatoire de droit

Dirk Trompeter